



G-Technology®



# G-DRIVE® ev ATC

with Thunderbolt™

Product Manual



## **Table of Contents**

### **About Your G-DRIVE ev ATC with Thunderbolt**

Introduction.....	4
What's in the Box .....	5
System Requirements .....	5
Overview of the Drive.....	6
Easy Installation for Mac .....	9
Disconnect the Drive .....	9

### **Using Your Drive on Mac**

Use with Time Machine.....	11
Initialize Drive for Mac.....	13
Restore the Drive Icon.....	16
Reformat with Partitions.....	18

### **Using Your Drive on Windows**

Windows Use .....	23
Cross Platform Use.....	24

### **Safety & General Use**

Safety Precautions .....	28
Backup Your Data .....	29

### **Support & Warranty**

Technical Support .....	31
Limited Warranty.....	32
Copyright.....	34



## About Your G-DRIVE® ev ATC with Thunderbolt

- Introduction ..... p.4
- What's in the Box ..... p.5
- System Requirements ..... p.5
- Overview of the Drive ..... p.6
- Easy Installation for Mac ..... p.9
- Disconnect the Drive ..... p.9



## Introduction

Thank you for purchasing the G-DRIVE® ev ATC with Thunderbolt™ from G-Technology®. Made from a lightweight, shock-resistant compound, this all-terrain drive solution with tethered Thunderbolt 2 cable shields a high quality, lightweight (approximately 35% lighter than the G-DRIVE ev), removable, stand-alone G-DRIVE® ev RaW USB hard drive. When coupled with the All-Terrain case, the data on your G-DRIVE ev RaW is further protected from pressure, shock and dust. Equipped with a watertight drive compartment, the G-DRIVE ev ATC floats; should it be dropped into a pool of water up to 1ft for 30 seconds your data will remain protected. Perfect for in the field back-up, editing, transferring and storage, this durable 7200 RPM drive is formatted for Mac®, it can be easily reformatted for Windows® and comes with a 3-Year limited warranty.

As part of the Evolution Series, the G-DRIVE ev RaW can be used as a standalone device, inside the ev All Terrain Case or with the G-DOCK ev® with Thunderbolt for ultra-fast transfer rates and editing. The ev All-Terrain case is compatible with ev Series drives including the G-DRIVE® ev or G-DRIVE® ev SSD.



## What's in the Box

The following items are included in the box:

- G-DRIVE<sup>®</sup> ev ATC with Thunderbolt™ hard drive solution with tethered Thunderbolt cable
  - G-DRIVE<sup>®</sup> ev ATC with Thunderbolt hard drive solution consists of an outer 'ev All-Terrain case' and a removable hard drive known as 'G-DRIVE ev RaW'
- USB 3.0 cable (for use with G-DRIVE ev RaW)
- Quick Start Guide
- 3-Year limited warranty

If any items are missing, please contact G-Technology at [g-technology.com/support](http://g-technology.com/support).

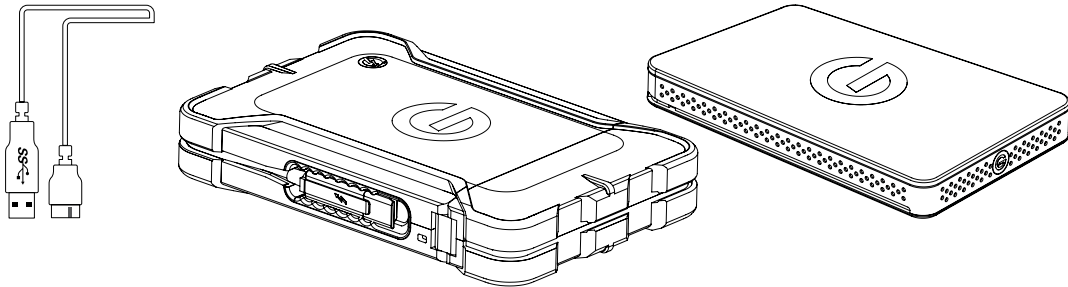

## System Requirements

The drive is set up at the factory for use with Mac OS<sup>®</sup> systems, formatted as 'HFS+ with Journaling', and supports the following Operating Systems:

- Mac OS<sup>®</sup> 10.9 +
- Windows<sup>®</sup> 10, Windows<sup>®</sup> 8.1 and Windows<sup>®</sup> 7

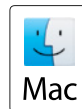

[See how to configure for Windows here.](#)

## Overview of the Drive

Your G-DRIVE ev ATC with Thunderbolt is designed for providing easy access to your precious content stored on the drive and providing everyday protection. The G-DRIVE ev ATC with Thunderbolt drive solution consists of two parts:

1. ev All-Terrain case with Thunderbolt
2. Removable G-DRIVE ev RaW USB hard drive

### ev All-Terrain case with Thunderbolt

The ev All-Terrain Case with Thunderbolt provides easy connectivity with its tethered Thunderbolt cable. The cable can be accessed from the left hand side of the drive.

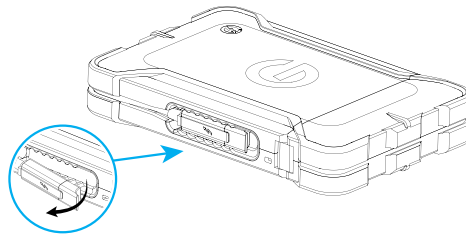

Simply remove the cover which protects the connector and plug-in to the Thunderbolt port on your laptop or desktop. The cover remains attached to the cable so that you don't have to worry about losing it.

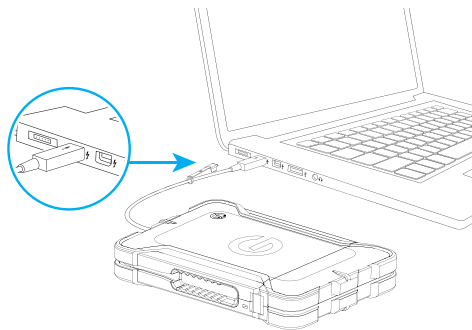

The Power & Activity LED on the front of the unit will glow when power is applied via the Thunderbolt port. The light will flash more brightly as data is transferred to or from the hard drive.

To access the removable hard drive, also called G-DRIVE ev RaW, simply open the latch located on the right side of the ev All-Terrain case. Gently pulling on the latch opens the drive compartment and you now have access to the G-DRIVE ev RaW. The removable hard drive also has an illuminated 'G' logo in the front that glows when the case is connected to a power source and flashes more brightly in case of drive activity.

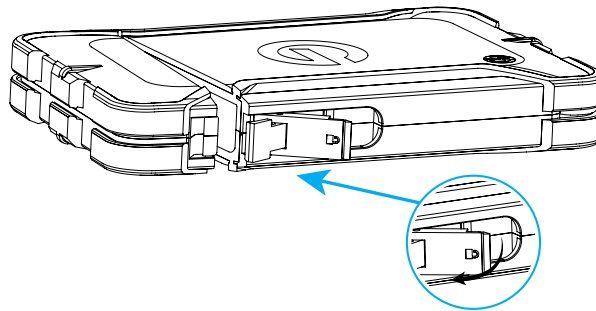

### **G-DRIVE ev RaW**

Inside the ev All-Terrain case you will find the G-DRIVE ev RaW USB hard drive. The G-DRIVE ev RaW can be removed from the case by simply pulling out of the case as shown in the image below. Please make sure that the drive is safely ejected from your desktop or laptop before removing the drive. Learn more about safely ejecting your drive [here](#).

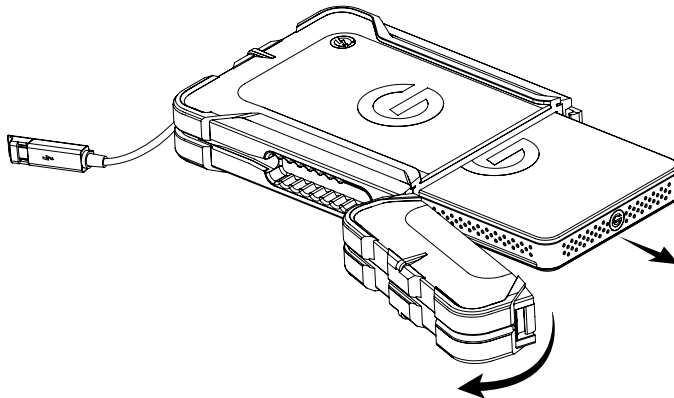

The G-DRIVE ev RaW can operate as a standalone USB hard drive or as a module for use inside G-DOCK ev<sup>®</sup> or G-DRIVE<sup>®</sup> ev ATC hard drive solution. The drive features an illuminated 'G' in the front, and a SATA Port and USB 3.0 Port on the back.

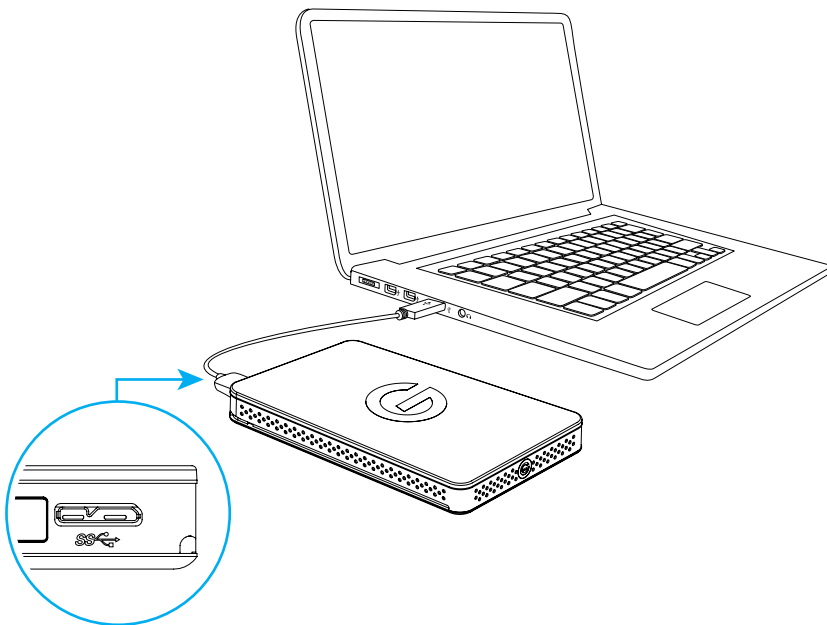
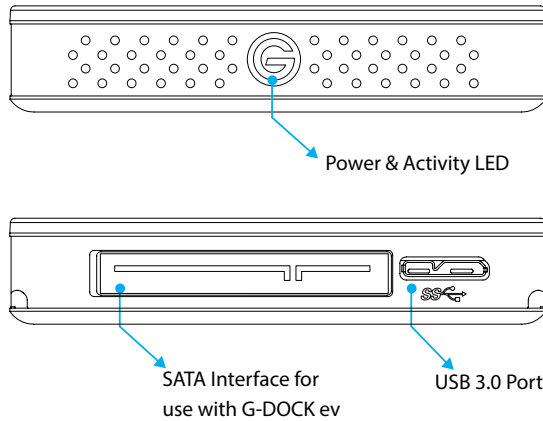



## Easy Installation for Mac

G-DRIVE ev ATC with Thunderbolt easily attaches to your computer via the Thunderbolt port. Simply use the tethered Thunderbolt cable to connect the drive to the appropriate port on your computer. The drive will automatically mount on the desktop if you are running Mac OS.

No AC power supply is necessary. The drive is bus-powered to eliminate the need to carry around an external AC power supply to use the drive.

## Disconnect the Drive

A great feature of G-DRIVE ev ATC with Thunderbolt is its ability to be connected and disconnected while your computer is running. However, to prevent failures and/or data loss, it is important to follow the steps below when disconnecting or 'unmounting' the drive from your computer.

1. Before disconnecting the drive, unmount the system by simply dragging the G-DRIVE ev ATC with Thunderbolt icon to the trash located in the dock. **Keyboard shortcut:** Select the drive icon and hit Command+E.
2. It is safe to remove the drive from your system when the drive icon is no longer present on your desktop.

## Helpful links

- To use your drive on Windows, go to [Windows Use](#).
- To use your drive on Mac® and Windows, go to [Cross Platform Use](#).



## Using Your Drive on Mac

- Use with Time Machine ..... p.11
- Initialize Drive for Mac ..... p.13
- Restore the Drive Icon ..... p.16
- Reformat with Partitions ..... p.18

## Use with Time Machine<sup>®</sup>

G-DRIVE ev ATC with Thunderbolt works seamlessly with Time Machine, the easy-to-use application that ships with your Mac and provides automatic backup for your files. The following steps will quickly set up your drive for use with Time Machine.

1. When you connect your drive for the first time, the Time Machine dialog box should automatically appear. Click the **Use as Backup Disk** button.

*\*If you have already configured Apple Time Machine, go to step 2.*

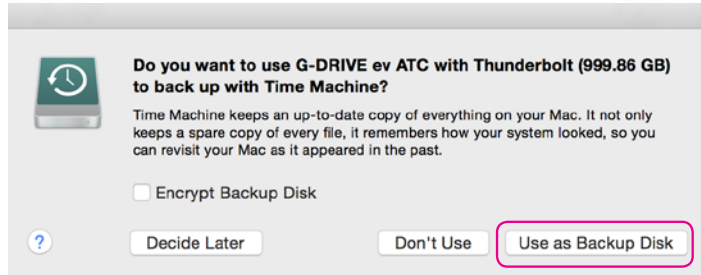

2. If the Time Machine dialog box did not launch, go to the Apple Menu > System Preferences. Click on the Time Machine icon. The Time Machine Preference panel will open. Click the **Select Backup Disk** button.

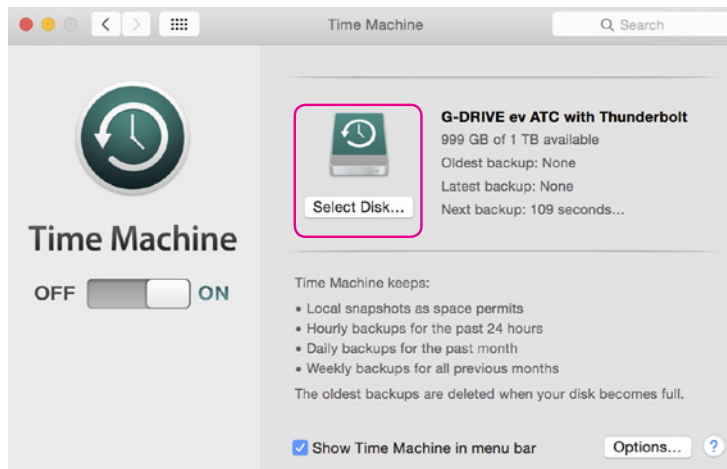

3. In the dialog box that appears, select your G-DRIVE ev ATC with Thunderbolt, then Click the **Use for Backup** button.

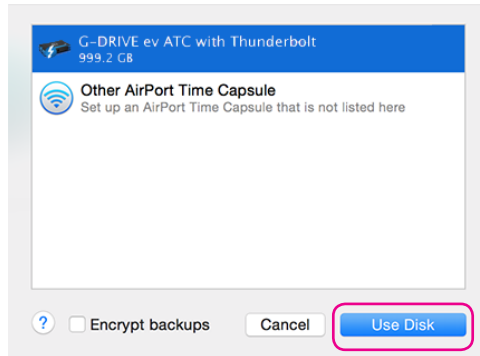

4. Make sure the Time Machine switch is set to **ON**. You can set its options by clicking the **Options** button. Do this to choose volumes, folders or files you do NOT want to backup.

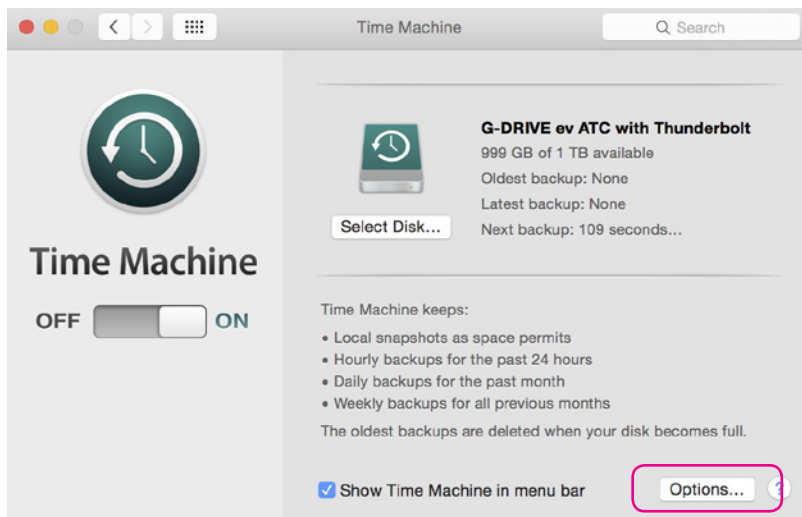

G-DRIVE ev ATC with Thunderbolt will now use Time Machine to back up your important files automatically. It's that easy!

## Initialize Drive for Mac

G-DRIVE ev ATC with Thunderbolt has been factory-formatted, or 'initialized', for use with Mac OS. Should you wish to reinitialize the drive—and quickly erase all contents of the drive—here are the steps:

1. First, open the Disk Utility program, located on your hard drive under Applications/ Utilities/ Disk Utility. The window below will appear, and your G-DRIVE ev ATC with Thunderbolt will be displayed in the left-hand column.
2. Select your drive by clicking its icon in the left-side column. Information about the drive will be displayed at the bottom of the window.
3. Select the **Erase** tab to view the formatting options. By default, the Format pop-up menu is set to the Mac OS Extended (Journaled) option.

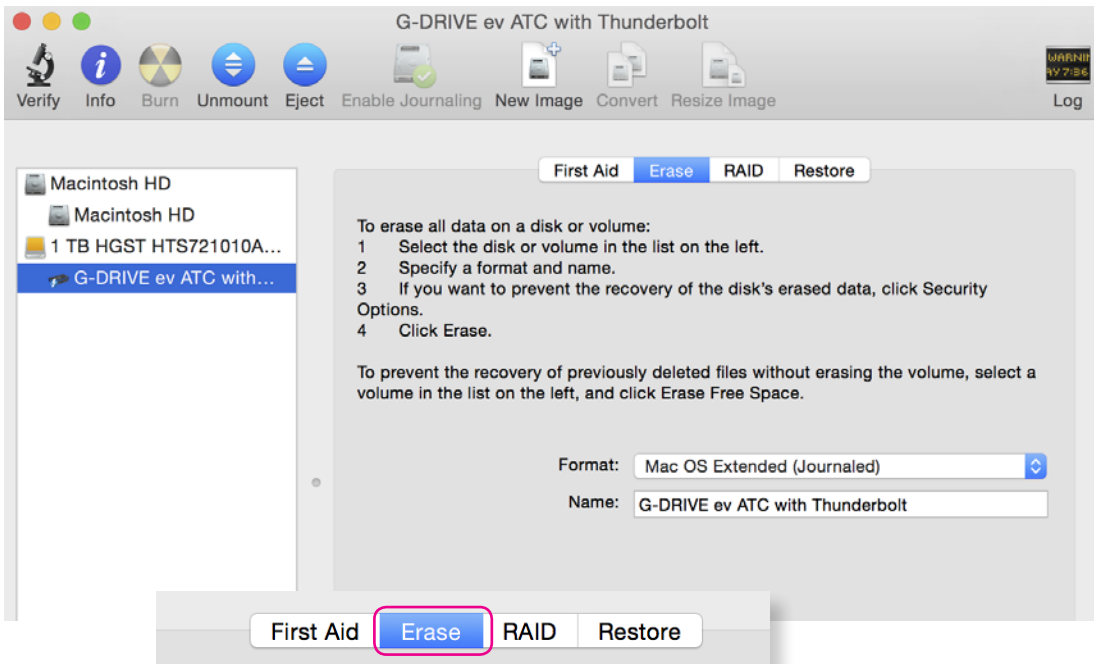

4. Choose the Format option that you prefer.

- Mac OS Extended (Journaled): Use this format if you intend to use the drive for Time Machine or to create a separate bootable installation of the OS.

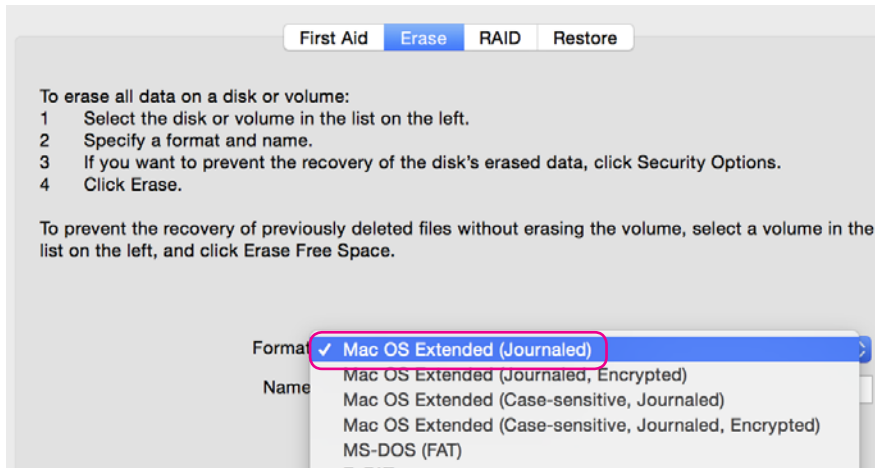

5. Click the Erase button in the lower right corner of the window. A dialog box will appear asking if you want to erase the G-DRIVE ev ATC with Thunderbolt partition.

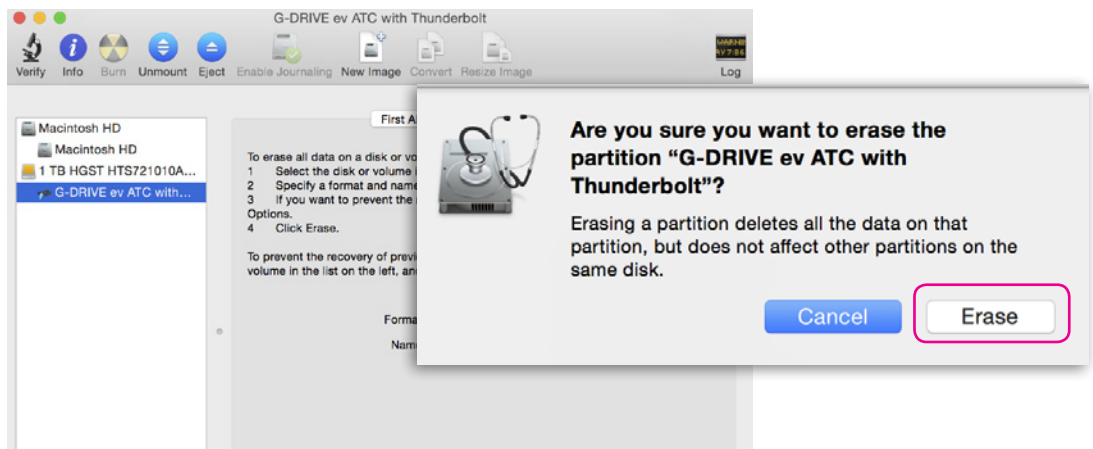

**WARNING: THIS NEXT STEP WILL ERASE ALL DATA ON YOUR DRIVE.**

6. Click on the **Erase** button to continue. A progress bar in the lower right corner of the window will show the progress of the disk's reformatting.

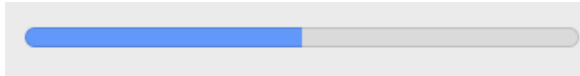

7. After the drive is reinitialized, you should automatically see the Time Machine® dialog box.

- Click the **Use as Backup Disk** button if you want to use the drive with Time Machine. For more info using the drive with Time Machine, [go here](#).
- Click the **Don't Use or Decide Later** button if you do not want to use Time Machine at this point.

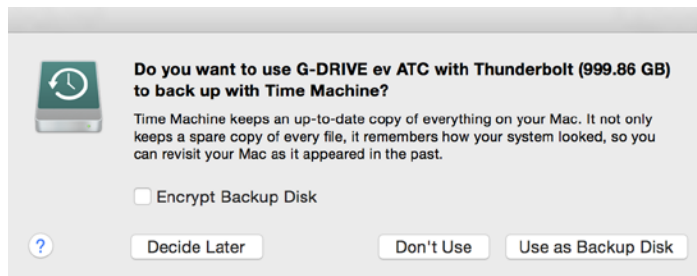

8. Quit the Disk Utility program. After reinitializing the drive, the custom icon for G-DRIVE ev ATC with Thunderbolt has been erased. You can optionally restore this icon with the steps on the [next page](#).

## Restore the Drive Icon

If the drive icon for your G-DRIVE ev ATC with Thunderbolt was erased during the reinitialization process (see [previous section](#)), you can restore the icon with the following easy steps.

**NOTE:** This process is not required for the operation of G-DRIVE ev ATC with Thunderbolt. However, it will make your drive's appearance on the computer desktop look nicer and more accurate.

1. To get the G-Technology Icon package, go to [g-technology.com/support](http://g-technology.com/support) and navigate to your product. There will be a link to download the icons.
2. Once downloaded, it should automatically open the G-Technology Icons folder as shown below. If not, double-click the Zip file to open. Next, double-click the **DMG** file to open the G-Technology Icons package.
3. Click to select the drive icon for G-DRIVE ev ATC with Thunderbolt in the package window. Press **Command+C** to copy the icon. (*below*)

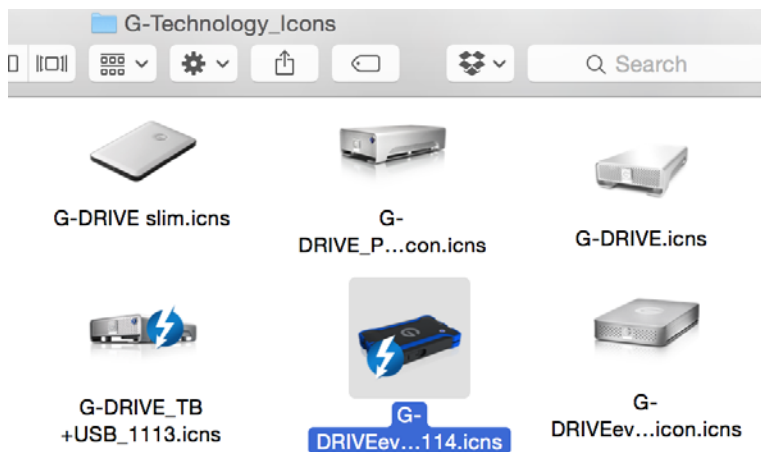



4. Select the G-DRIVE ev ATC with Thunderbolt icon on your desktop and press **Command+I**. This opens its Get Info window. *(below left)*
5. Select the default icon in the Get Info window. *(below left)*
6. Press Command+V to paste the custom G-DRIVE ev ATC with Thunderbolt icon into the **Get Info** window. *(below right)*

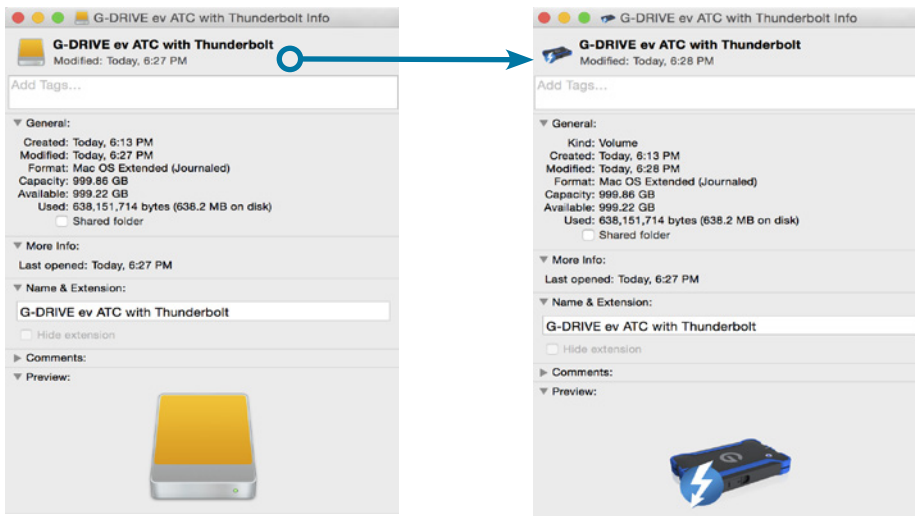

The icon for your G-DRIVE ev ATC with Thunderbolt has been restored and you can close the **Get Info** window. Your drive is now fully ready for use!

## Reformat with Partitions

'Partitioning' a hard drive is the process of dividing a hard drive into separate, discrete sections called 'volumes'. Each volume works like a separate disk. You can create up to 16 different partitions on a hard drive in the OS and each partition can be a different size and format.

With hard drives getting bigger, it is useful to partition your hard drive so sections of its space can be used for different purposes. For instance, segment user data from backup data, set up a multi-boot environment with different Operating Systems or create a dedicated capture scratch disk for programs like Final Cut Pro® and Adobe Premiere®.

The following steps will guide you through the simple process of partitioning your drive.

1. First, open the Disk Utility program. This application is located on your hard drive under Applications/Utilities/Disk Utility. The window below will appear. Your G-Technology drive will be displayed in the left-hand column.

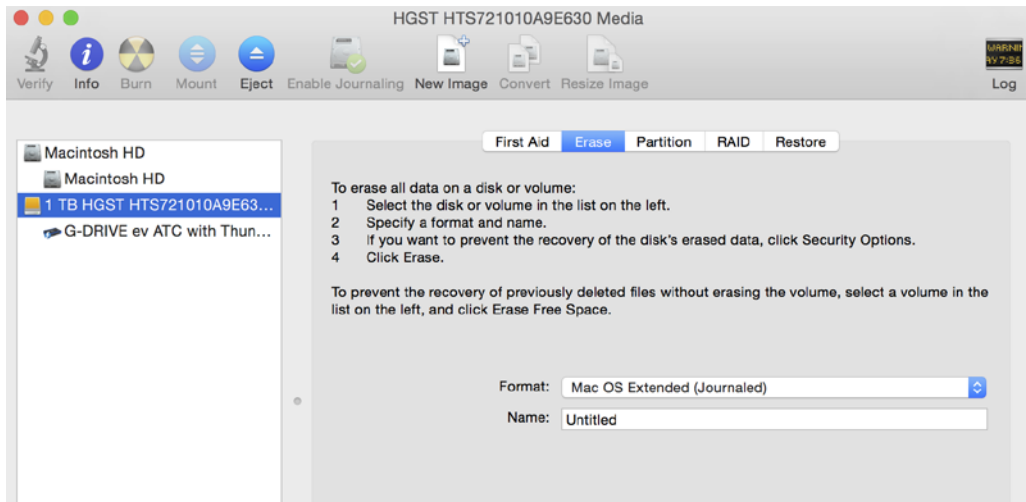

2. Select the Thunderbolt or USB icon – not the G-Technology drive icon – by clicking it in the left-side column.
3. Click on the **Partition** button in the main window.

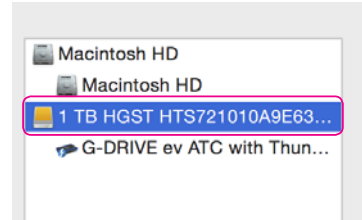

4. Select the number of partitions you would like from the Volume Scheme menu. Below, we have selected '2 Partitions' to create two partitions.

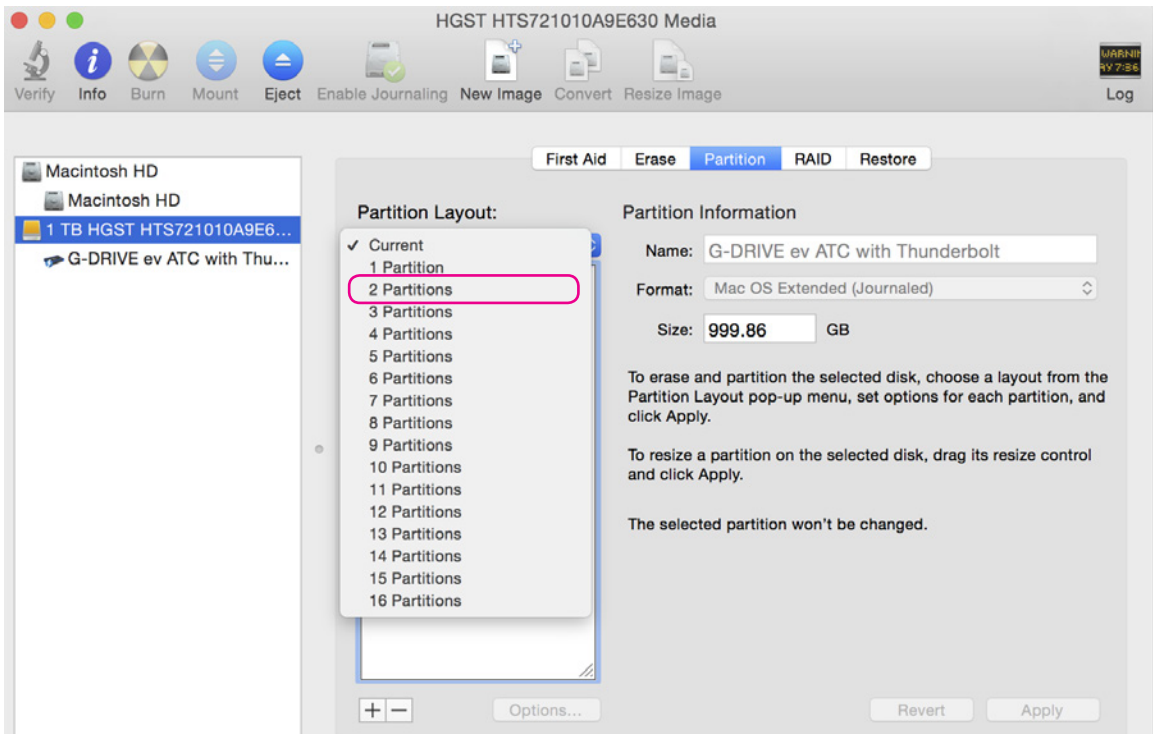

5. Click on the first partition in the Volume Scheme area. Your partition will be highlighted by a blue bounding box.
  - In the **Name** field, type a name for the partition.
  - From the Format menu, choose your desired disk format. If you will use your drive primarily on Mac OS, it is recommended to use Mac OS Extended or Mac OS Extended (Journaled). For info about formats, [go here](#).
  - In the **Size** field, type in a size for the partition. Alternately, you can drag the bar in between each partition to quickly change the size.
6. Repeat this process for each partition you have created.
7. Click the **Apply** button in the lower right corner of the window. A dialog box will appear asking if you want to partition the G-Technology drive.

**WARNING: THIS NEXT STEP WILL ERASE ALL DATA ON YOUR DRIVE.**

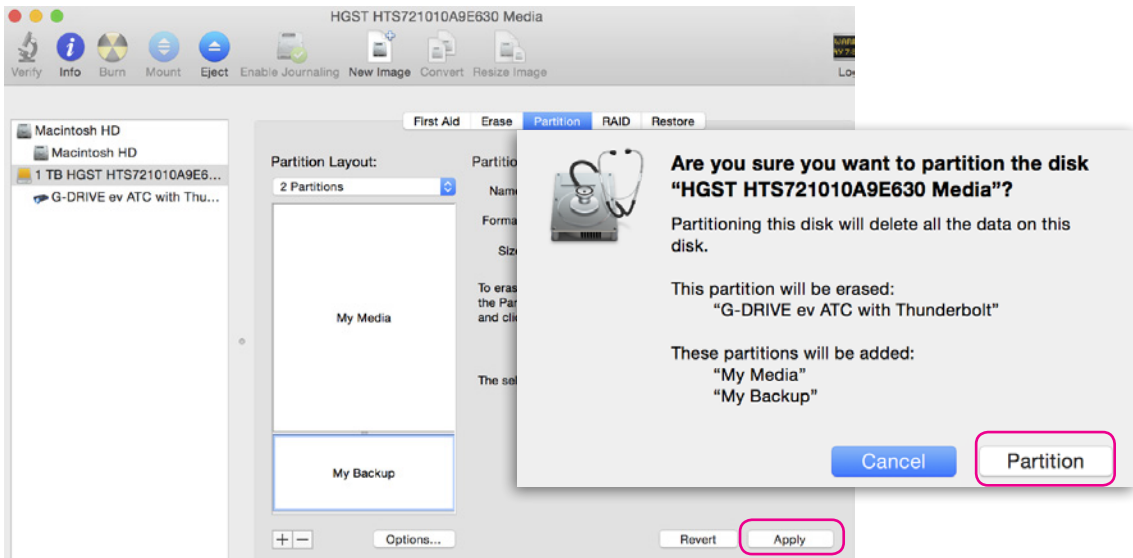

8. Click on the **Partition** button to continue. A progress bar in the lower right corner of the window will show you the progress of the disk's reformatting.



9. When partitioning is complete, the multiple partitions will be displayed in the left-hand panel of Disk Utility.

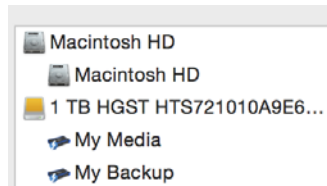

10. Quit the Disk Utility program. After reinitializing the drive, the custom icon for the G-Technology drive will have been erased. You can optionally restore this icon to each partition with the steps on [this page](#).

11. The multiple partitions of the G-Technology drive will be displayed on the desktop. Your drive is now setup with two or more partitions and ready for use.

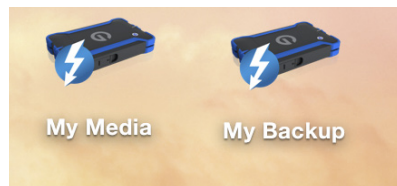



## Using Your Drive on Windows®

- Windows Use ..... p.23
- Cross Platform Use ..... p.24



## Windows Use

G-DRIVE ev ATC with Thunderbolt is set up at the factory for use with Mac OS 10.9 + systems. A simple initialization will prepare your drive for use with Windows 10, Windows 8.1 and Windows 7 systems.

For helpful information on configuring and using your drive with Windows, please visit [g-technology.com/support](http://g-technology.com/support).

## Cross Platform Use

You can set up G-DRIVE ev ATC with Thunderbolt for use on both Windows and Mac® systems by formatting the drive as 'FAT32'. To do this, use the Disk Utility application and format the drive to MS-DOS (FAT), also known as FAT32.

1. First, open the Disk Utility program. This application is located on your hard drive under Applications/Utilities/Disk Utility. The window below will appear. Your G-DRIVE ev ATC with Thunderbolt will be displayed in the left-hand column.
2. Select the G-DRIVE ev ATC with Thunderbolt by clicking its drive icon in the left-side column. Information about the drive will be displayed at the bottom of the window.
3. Select the **Erase** tab to view the formatting options. By default, the Format pop-up menu is set to the Mac OS Extended (Journaled) option.

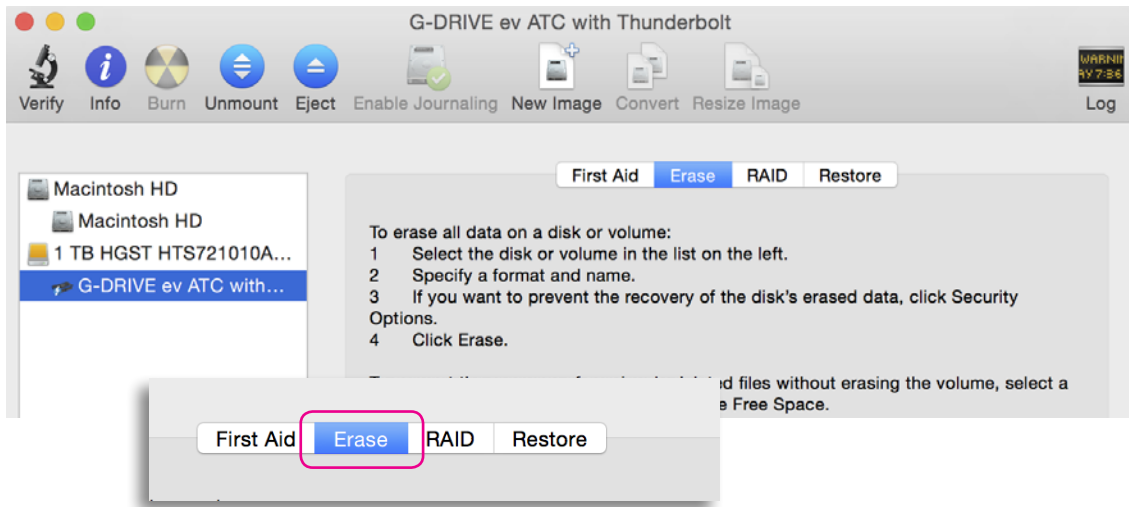



4. Select MS-DOS File System from the Format pop-up menu. This will format the drive to FAT32.

NOTE: You may need to rename the drive because FAT32 does not support more than 11 characters in the drive name.

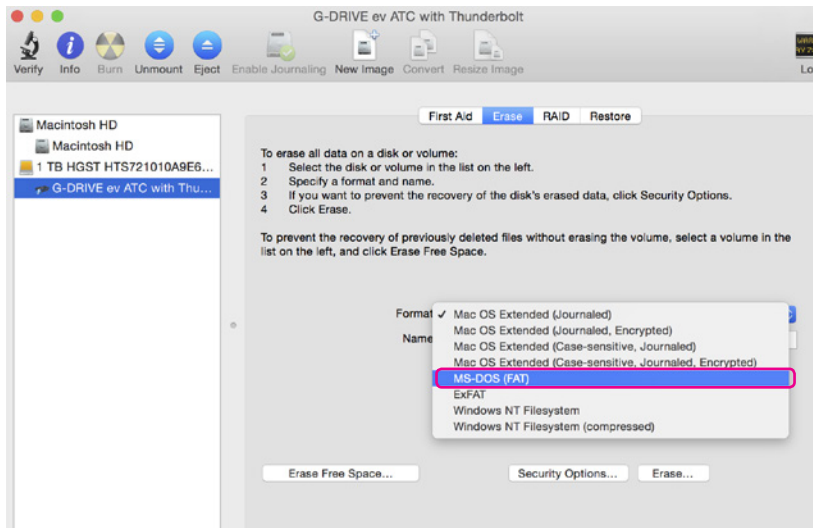

5. Click the **Erase** button in the lower right corner of the window. A dialog box will appear asking if you want to erase the G-DRIVE ev ATC with Thunderbolt partition.

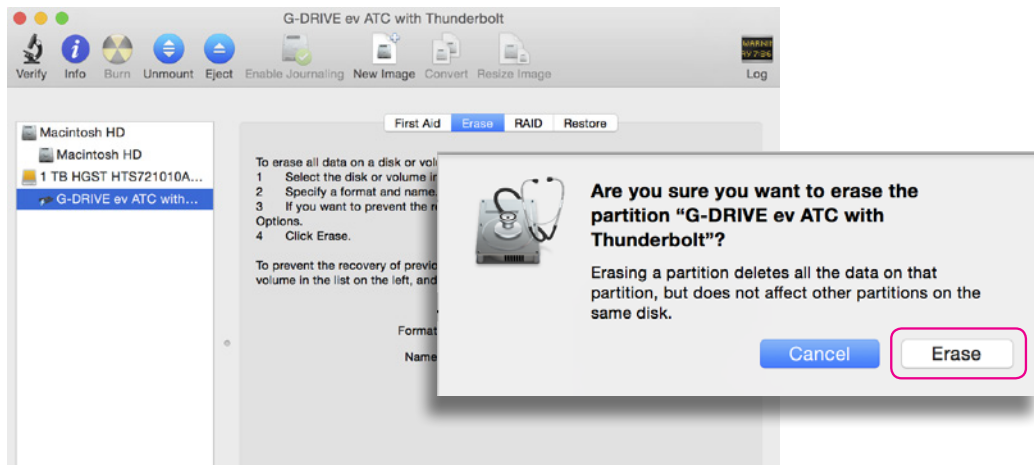

**WARNING: THIS NEXT STEP WILL ERASE ALL DATA ON YOUR DRIVE.**

6. Click the **Erase** button. A progress bar in the lower right corner of the window will show the progress of the disk's reformatting. Your drive will be formatted to its full capacity as FAT32.

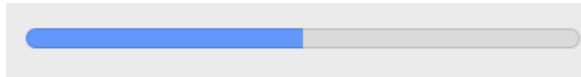

7. Quit the Disk Utility program. You are finished!

8. After reinitializing, the custom icon for the G-DRIVE ev ATC with Thunderbolt will be erased. No icons are available for FAT32.

With the FAT32 format you will be able to read/write on Windows 8, 7 and Vista (with reformat), as well as Mac OS 10.7+ machines.

### **Limitations with FAT32**

There are some limitations when using FAT32.

The 'MS-DOS File System' cannot write files over 4 GB. If you are working with files over 4 GB, you may want to choose a software option like MacDrive, [www.macdrive.com](http://www.macdrive.com). MacDrive is a Windows software that enables you to mount Mac-formatted drives on your Windows computer.



## Safety & General Use

- Safety Precautions ..... p.28
- Backup Your Data ..... p.29



## Safety Precautions

The warranty on G-Technology storage solution may be void as a result of the failure to respect the precautions listed here. If you detect a problem with your drive, please contact our **Technical Support department**.

*If the product is returned with damage caused by improper handling, the warranty will be void and liability will rest with the user. Please read our **Limited Warranty**.*

- **Servicing:** Your drive contains no other user-serviceable parts. If it appears to be malfunctioning, have it inspected by a qualified Technical Support representative.
- **Moisture:** Place the device away from moisture or liquids. To reduce the risk of damage, do not expose your drive to rain or moisture. Do not use it in damp or wet conditions. Never place objects containing liquids on the drive as they may spill into its openings.
- **Ventilation:** Place the device in a vented area. The drive should never be placed near or over a radiator or heat source.
- **Temperature:** Do not expose this drive to temperatures outside the range of 5°C to 35°C (41°F to 95°F); or to operational humidity beyond 5%-80%, non-condensing, or non-operating humidity beyond 10%-90%, non-condensing. Avoid placing your drive near a source of heat, or exposing it to sunlight (even through a window), or in an environment that is too cold or humid.
- **Physical Damage:** Do not place heavy objects on your drive. Never use excessive force on your drive.

## Backup Your Data

The disk drive contained in your G-DRIVE ev ATC with Thunderbolt device is a delicate electronic instrument and is susceptible to damage due to excessive physical shock. Under no circumstances will G-Technology be held liable for the recovery or restoration of lost data. Any loss, corruption or destruction of data while using a G-Technology drive is the sole responsibility of the user.

### Make two backups

To help prevent the loss of your data, we highly recommend that you keep **TWO** copies of your data in separate storage locations. Keep one copy on your G-Technology drive. Keep a second copy on your internal hard drive, another G-Technology drive, or a form of removable storage media.



## Support & Warranty

- Technical Support ..... p.31
- Limited Warranty ..... p.32
- Copyright ..... p.34



## Technical Support

Thank you for purchasing G-DRIVE ev ATC with Thunderbolt. If you have any comments or questions about this manual or the product, please let us know!

At G-Technology, we appreciate and value our customers, and strive to give you the finest quality products, service and support. If you encounter any difficulties while installing or using any of the G-DRIVE ev ATC with Thunderbolt series, please contact G-Technology Technical Support at [www.g-technology.com/support](http://www.g-technology.com/support).

### Helpful information for support

When contacting Technical Support, it's best to be in front of your computer and have the following information available:

- Your G-DRIVE ev ATC with Thunderbolt serial number (on the bottom side of your unit)
- Operating System and version
- Computer brand and model
- List of other devices attached to your computer

## Limited Warranty

HGST, a Western Digital Company (“HGST”) Including G-Technology for External Hard Disk Drives.

### What does this limited warranty cover?

This Limited Warranty applies to new HGST products purchased from an authorized HGST dealer by the original purchaser for normal use and not for resale. HGST warrants that a covered product is free from defects in materials and workmanship, with the exceptions stated below.

### How long does limited warranty coverage last?

This limited warranty lasts for 1 year, 2 years, 3 years or 5 years, or a fixed period from date of purchase, depending on when and where it was originally purchased. To determine the warranty specifically for your product, visit [g-technology.com](http://g-technology.com). A valid proof of purchase may be required to prove eligibility. If you do not have a valid proof of purchase, the limited warranty period will be measured from the date of sale from HGST to the authorized distributor.

### What does this limited warranty not cover?

The limited warranty does not cover damage resulting from commercial use, misuse, accident, modification or alteration to hardware or software, tampering, unsuitable physical or operating environment beyond product specifications, improper maintenance, or failure caused by a product for which HGST is not responsible.

There is no warranty of uninterrupted or error-free operation. There is no warranty for loss of data—you must regularly back up the data stored on your product to a separate storage product. There is no warranty for product with removed or altered identification labels.

HGST DOES NOT PROVIDE ANY OTHER WARRANTIES OF ANY KIND, INCLUDING, BUT NOT LIMITED TO, THE IMPLIED WARRANTIES OR CONDITIONS OF MERCHANTABILITY AND FITNESS FOR A PARTICULAR PURPOSE. SOME JURISDICTIONS DO NOT ALLOW THE LIMITATION OF IMPLIED WARRANTIES, SO THIS LIMITATION MAY NOT APPLY TO YOU. HGST is not responsible for returning to you product which is not covered by this limited warranty.



## What must you do?

If you are having trouble with a product, before seeking limited warranty service, first follow the troubleshooting procedures that HGST or your reseller provides.

To obtain limited warranty service, you must first obtain a Return Materials Authorization (RMA) and ship-to address by contacting G-Technology at [www.g-technology.com/support](http://www.g-technology.com/support). Please follow the instructions found on the website. You must return the covered hard disk drive using approved packaging to our logistics center. You must pay any associated transportation charges, duties and insurance in shipping the drive to our logistics center. You should remove all personal information from the product prior to its return.

## What will HGST do?

HGST will replace the drive with a functionally equivalent replacement product, transportation prepaid. HGST may replace your product with a product that was previously used, repaired and tested to meet HGST specifications. You receive title to the replaced product at delivery to carrier at HGST shipping point. You are responsible for importation of the replaced product, if applicable. HGST will not return the original drive to consumers; therefore, the consumer is responsible for moving data to another media before returning. Data Recovery is not covered under this warranty and is not part of the warranty returns process. HGST warrants that the replaced products are covered for the remainder of the original product warranty or 90 days, whichever is greater.

## How is our liability limited?

HGST AND ITS AFFILIATES, SUPPLIERS, DISTRIBUTORS, AND RESELLERS ARE NOT LIABLE FOR ANY OF THE FOLLOWING: 1) THIRD-PARTY CLAIMS AGAINST YOU FOR DAMAGES (OTHER THAN BODILY INJURY INCLUDING DEATH AND TANGIBLE PERSONAL PROPERTY; 2) LOSS OF, OR DAMAGE TO, YOUR DATA; OR 3) SPECIAL, INCIDENTAL, OR INDIRECT DAMAGES OR FOR ANY ECONOMIC CONSEQUENTIAL DAMAGES (INCLUDING LOST PROFITS OR SAVINGS), EVEN IF INFORMED OF THE POSSIBILITY. SOME JURISDICTIONS DO NOT ALLOW LIMITATION OF LIABILITY, INCIDENTAL DAMAGES, OR CONSEQUENTIAL DAMAGES, SO THE ABOVE LIMITATIONS MAY NOT APPLY TO YOU.

## How do local laws apply?

THIS LIMITED WARRANTY GIVES YOU SPECIFIC LEGAL RIGHTS, AND YOU MAY ALSO HAVE OTHER RIGHTS WHICH VARY FROM JURISDICTION TO JURISDICTION.

## CAPACITY DEFINITION AND DISCLAIMER

**For G-Technology products 1TB or greater:** “One gigabyte (GB) is equal to one billion bytes and one terabyte (TB) equals 1,000 GB (one trillion bytes). Accessible capacity will vary from the stated capacity due to formatting and partitioning of the hard drive, the computer’s OPERATING SYSTEM, and other factors”

**For G-Technology products less than 1TB:** “One gigabyte (GB) is equal to one billion bytes when referring to hard drive capacity. Accessible capacity will vary depending on the operating environment and formatting.”

## Copyright

Thunderbolt and the Thunderbolt logo are trademarks of Intel Corporation in the U.S. and/or other countries.

G-Technology, G-DOCK ev and G-DRIVE are trademarks of Western Digital Corporation or its affiliates in the United States and/or other countries. Other trademarks are the property of their respective owners. Apple, Mac, FireWire, MacBook Pro, Time Machine and the Mac logo are trademarks of Apple, Inc. Microsoft, Windows, Windows Vista and Windows XP are trademarks or registered trademarks of Microsoft Corporation in the US and/or other countries. Other trademarks are the property of their respective owners.

©2016 G-Technology, a Western Digital Corporation brand. All rights reserved. R3 05/16



G-Technology®

#### USA

---



GTechnology



GTechStorage



GTechnology



GTechnologyStorage

#### EUROPE

---



GTechnologyEUROPE



GTechEurope



GTechnology

#### FRANCE

---



G-TechnologyFR



GTechFR

#### GERMANY

---



G-TechnologyDE



GTechDE

#### AP-SOUTH

---



G-TechnologyAP

#### TAIWAN

---



HGST.com.tw

#### HONG-KONG

---



G-TechnologyHK

#### JAPAN

---



GTechnologyJP

#### AP-CHINA

---



e.weibo.com/u/2536203800

[g-technology.com](http://g-technology.com)